

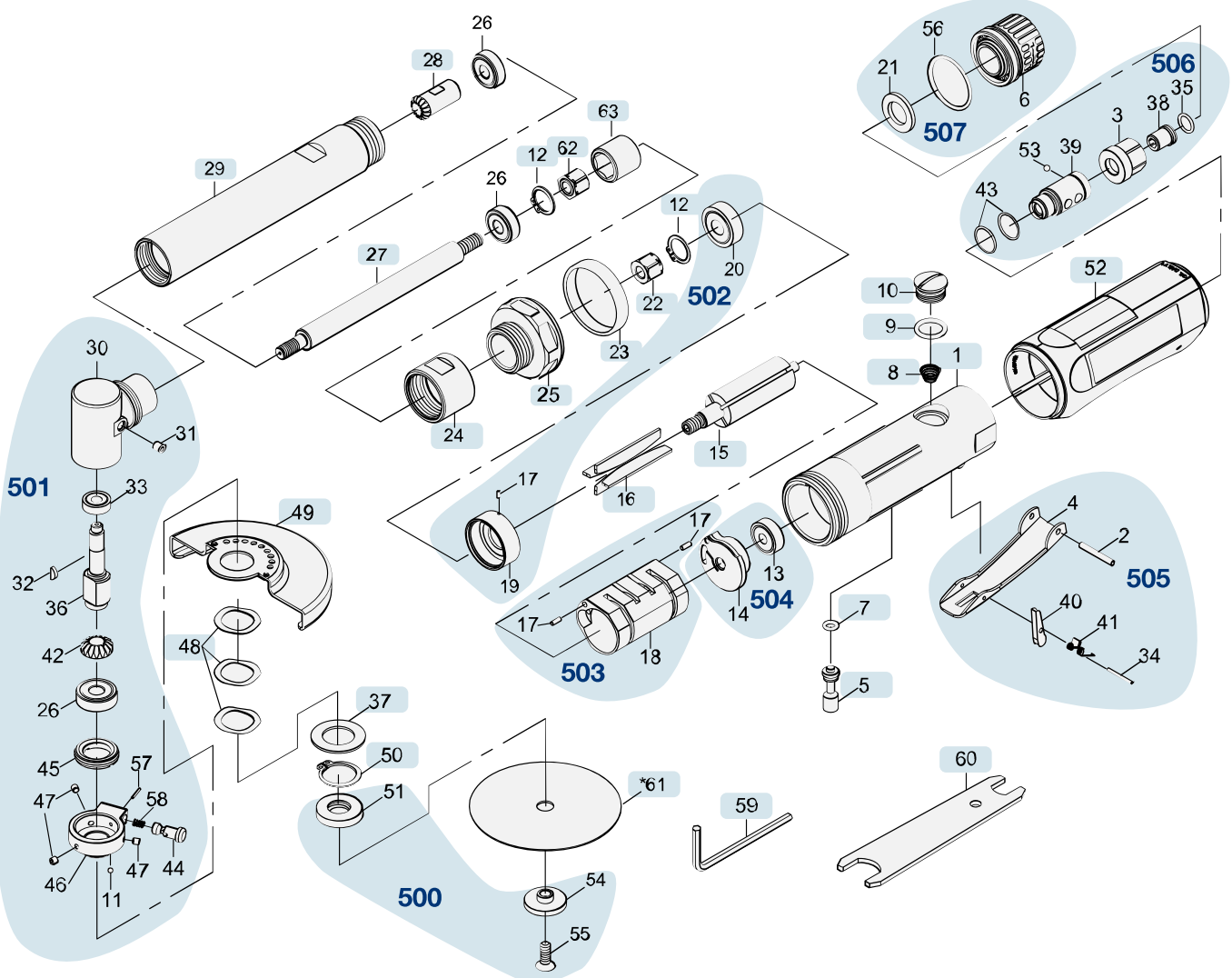

Ersatzteile 9033-8

Spare parts · Pièces de rechange



Pos	HAZET No.	Bezeichnung	Designation	Désignation	
1	9033-8-09	Motor-Gehäuse	Engine housing	Boîtier de moteur	1
5	9033-8-010				1
7	9033-8-011				1
8	9033-8-012				1
9	9033-8-013				1
10	9033-8-014				1
12	9033-8-015				1
12	9033-8-016/2N				1
15	9033-8-017				1
16	9033-8-018/4	Lamellen · Satz à 4 Stück	Blades · set of 4	Lamelles · jeu de 4 pièces	4

Pos	<i>HAZET</i> No.	Bezeichnung	Designation	Désignation	
22	9033-8-019				1
22	9033-8-020 N				1
23	9033-8-021				1
24	9033-8-022				1
25	9033-8-024				1
27	9033-8-025				1
27	9033-8-025 N				1
28	9033-8-026	Kegelgetriebe	<i>Bevel gear</i>	<i>Engrenage conique</i>	1
29	9033-8-027				1
37	9033-8-028				1
48	9033-8-029				3
49	9033-8-030	Abdeckscheibe	<i>Cover disc</i>	<i>Disque de couverture</i>	1
50	9033-8-031	Sicherungsring	<i>Circlip</i>	<i>Circlip</i>	1
52	9033-8-032	Gummigriff	<i>Rubber handle</i>	<i>Poignée en caoutchouc</i>	1
59	9033-8-033	Winkelschlüssel · Innensechskant 4 mm	<i>Hex-head wrench · inside hexagon 4 mm</i>	<i>Tournevis coudé · 6 pans intérieurs de 4 mm</i>	1
60	9033-8-034	Maulschlüssel · 11 x 17 mm	<i>Open-end wrench · 11 x 17 mm</i>	<i>Clé à fourche · 11 x 17 mm</i>	1
61	9033-8-035				1
62	9033-8-036 N				1
63	9033-8-037 N	Verbindungsteil	<i>Connector</i>	<i>Pièce intercalaire</i>	1
500	9033-8-01/3	Befestigungs Satz	<i>Fastening set</i>	<i>Jeu de fixation</i>	1
501	9033-8-02/16	Antriebskopf · komplett	<i>Drive head · complete</i>	<i>Tête d'entraînement · complète</i>	1
502	9033-8-03/3				1
502	9033-8-03/3 N				1
503	9033-8-04/3				1
504	9033-8-05/2				1
505	9033-8-06/5	Betätigungshebel	<i>Operating lever</i>	<i>Gâchette</i>	1
506	9033-8-07/7	Lufteinlass · komplett	<i>Air inlet · complete</i>	<i>Admission d'air · complète</i>	1
507	9033-8-08/3	Luftauslass	<i>Air outlet</i>	<i>Échappement d'air</i>	1



DE

HAZET Service online:
www.hazet.de/de/home/service/



EN

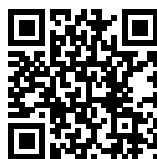



DE

HAZET Ersatzteil-Shop
HAZET Spare-parts-shop:
www.hazet.de/ersatzteil-shop



EN

Zur Bestellung und für Rückfragen wenden Sie sich bitte an unsere Service-Abteilung
For Orders and questions please refer to our service-centre

 +49 (0) 21 91 / 7 92 355 ·  +49 (0) 21 91 / 7 92 523 ·  service-center@hazet.de

HAZET-WERK – Hermann Zerver GmbH & Co. KG ·  10 04 61 · 42804 REMSCHEID

 Gùldenwerther Bahnhofstrasse 25 – 29 · 42857 REMSCHEID · GERMANY