

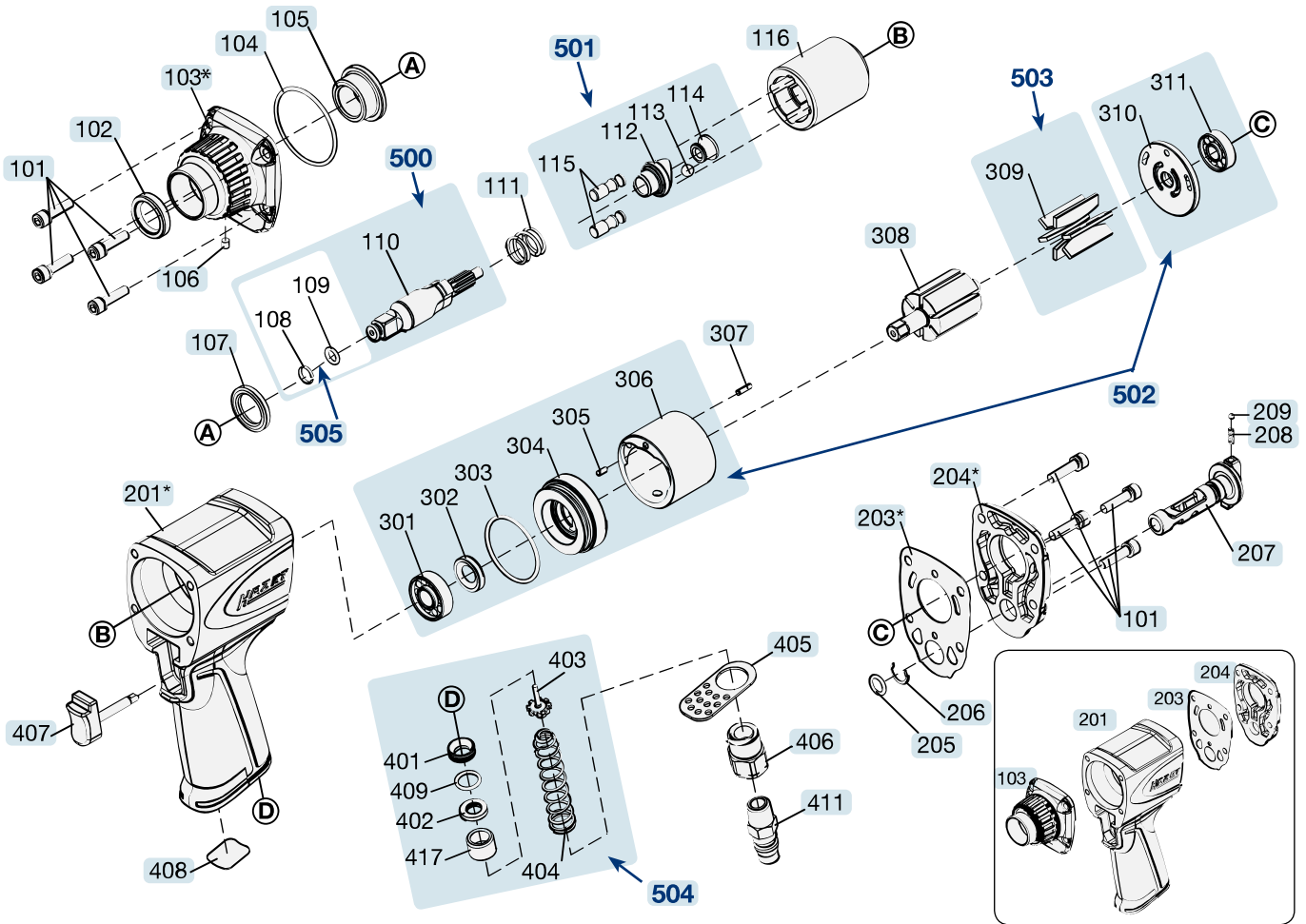

# Ersatzteile 9011 MG

Spare parts · Pièces de rechange



Pos	HAZET No.	Bezeichnung	Designation	Désignation	
101	9011 MG-03/8				8
102	9011 MG-05/5	Dichtungsring · Satz à 5 Stück	Sealing rings · set of 5	Joints d'étanchéité · jeu de 5 pièces	1
103	9011 MG-06				1
103	9011 MG-06 N				1
104	9011 MG-07/5				1
105	9011 MG-08/3	Schlagwerk-Buchse	Striking mechanism bush	Douille de mécanisme de frappe	1
106	9011 MG-09/10	Schmiernippel · Satz à 10 Stück	Lubricating nipples · set of 10	Graisseurs · jeu de 10 pièces	1
107	9011 MG-010/2				1
111	9011 MG-011/5				1
116	9011 MG-012				1
201	9011 MG-013				1
201	9011 MG-013 N				1

Pos	HAZET No.	Bezeichnung	Designation	Désignation	
203	9011 MG-04/10				1
203	9011 MG-04/10 N				1
204	9011 MG-014				1
204	9011 MG-014 N				1
205	9011 MG-015/15	O-Ring · Satz à 15 Stück	<i>O-ring · set of 15</i>	<i>Joints toriques · jeu de 15 pièces</i>	1
206	9011 MG-016/10	Sicherungsring · Satz à 10 Stück	<i>Circlips · set of 10</i>	<i>Circlips · jeu de 10 pièces</i>	1
207	9011 MG-017				1
208	9011 MG-018/15				1
209	9011 MG-019/15				1
307	9011 MG-020/15				1
308	9011 MG-021	Rotor	<i>Rotor</i>	<i>Rotor</i>	1
405	9011 MG-022/5				1
406	9011 MG-023	Lufteinlass	<i>Air inlet</i>	<i>Admission d'air</i>	1
407	9011 MG-024				1
408	9011 MG-025/10	Auslass-Sieb · Satz à 10 Stück	<i>Outlet strainer · set of 10</i>	<i>Tamis de vidange · jeu de 10 pièces</i>	1
500	9011 MG-01/3	Vierkant	<i>Square</i>	<i>Quatre pans</i>	1
501	9011 MG-01/5	Stift-Schlagwerk	<i>Pin clutch mechanism</i>	<i>Système de frappe</i>	1
502	9011 MG-01/8				1
503	9011 MG-01/6				1
504	9011 MG-02/6				1
505	9011 MG-01/2	Ring Satz	<i>Ring set</i>	<i>Jeu de bagues</i>	1



DE

HAZET Service online:  
[www.hazet.de/de/home/service/](http://www.hazet.de/de/home/service/)



EN

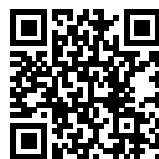



DE

HAZET Ersatzteil-Shop  
 HAZET Spare-parts-shop:  
[www.hazet.de/ersatzteil-shop](http://www.hazet.de/ersatzteil-shop)



EN

Zur Bestellung und für Rückfragen wenden Sie Sich bitte an unsere Service-Abteilung  
 For Orders and questions please refer to our service-centre

 +49 (0) 21 91 / 7 92 355 ·  +49 (0) 21 91 / 7 92 523 ·  [service-center@hazet.de](mailto:service-center@hazet.de)

**HAZET-WERK** – Hermann Zerver GmbH & Co. KG ·  10 04 61 · 42804 REMSCHEID

 Gùldenwerther Bahnhofstrasse 25 – 29 · 42857 REMSCHEID · GERMANY